

Design Options

POLISH SANDING

- To remove cross-grain scratches on door rails, front and back, (150 grit) is available at a cost of \$4.65 per design cost.

MULTI-PANEL DOOR INFORMATION

- Multi-panel doors will have the design price charged per panel plus material price. All multi-panel doors will be manufactured with equal panels unless otherwise specified.
- Non standard framing charges see below.

NON STANDARD FRAMING

- Standard framing size is 2-5/16"
- Doors are available with stiles and rails wider than standard at an extra charge of: Std. to 6" - \$1.75 per piece; 6-1/16" to 8" - \$8.00 per piece; 8-1/16" to 14" - \$14.00 per piece; over 14" - time & material per piece.
- Undersized framing is available std. to 3/4" minimum - \$3.50 per door.

LIPPING

- All design costs include lipping charge with the exception of doors over 48" and doors with multiple openings. Cost for multiple opening doors is \$2.35 per additional opening, an additional charge of \$2.35 will be applied to doors over 48".

PUTTY PIN HOLES

- Putty pin holes on back of door - \$0.50 per door.

OVER SIZE PANEL CHARGE

- Any panel over 24" wide, any slab or panel over 6" wide and 60" long - \$40.00 per piece.

FRAME ONLY

- Design cost same as door.
- Come with clear vinyl retention molding.
- Outside corner or flush molding available upon request.
- Calculate material square footage; 10 x actual length or width (which ever is longer).

PEGS

- Round
 - Square
 - Square diagonal
- } \$2.25 per peg.
- Please specify amount and location of pegs.

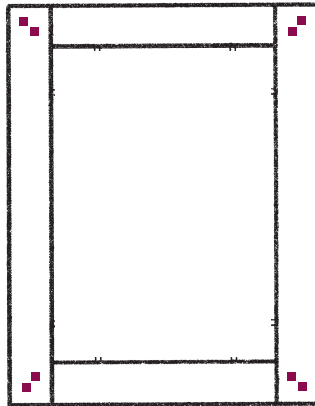

APPLIANCE SLOT

- \$10.00 per door.

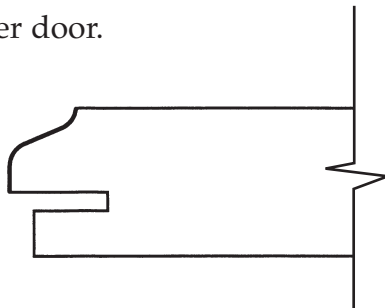

Design Options

LITE MULLION OPTIONS

- Lite mullion doors are available in many options.
 - Standard costs \$4.95 per lite for equal spacing.
 - Standard costs \$7.25 per lite for unequal spacing
 - True divided cost \$4.60 per lite, in addition to standard cost.
 - Available with flush rout retention moulding, outside corner moulding and clear vinyl groove type.
 - Special designs call for pricing.

9 Lite Offset

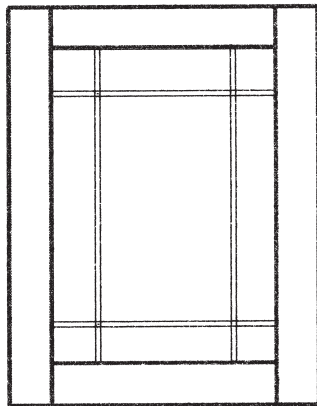

6 Lite

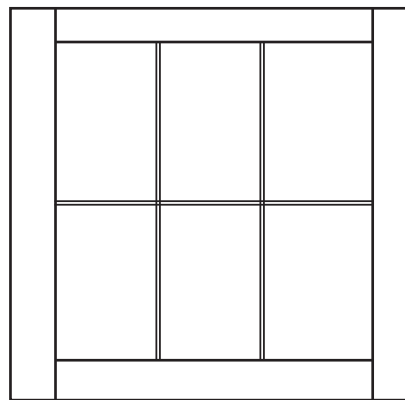

7 Lite Gothic

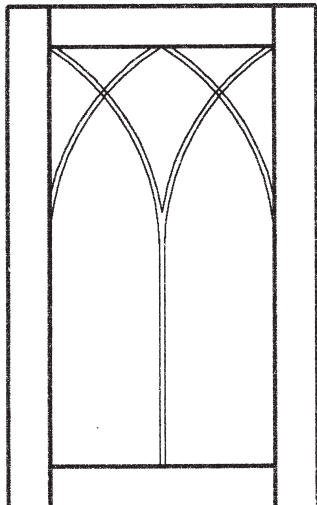

9 Lite

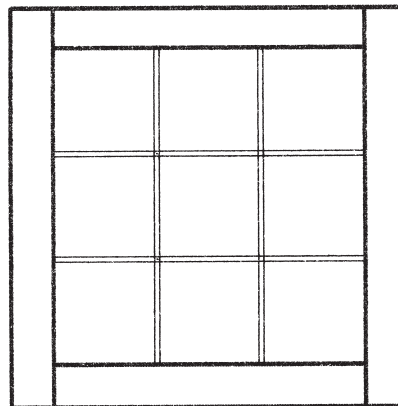

MULLION PROFILES

★ Please note illustrations are for visual concept only, not to scale.



Standard



Square



Ogee



Slant

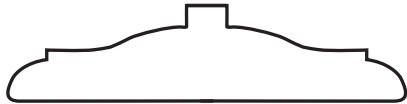

Elite



Executive

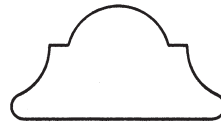

Molding #14

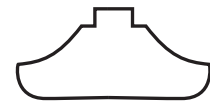

Cove

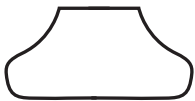

WC

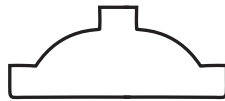

Quartered

SPECIAL ARCHED CURVED VALANCES

- Available as per your specific design.
- Single & multi panel designs.
- Flat panel or raised panel options.
- Custom made to size.
- Quotes by request.

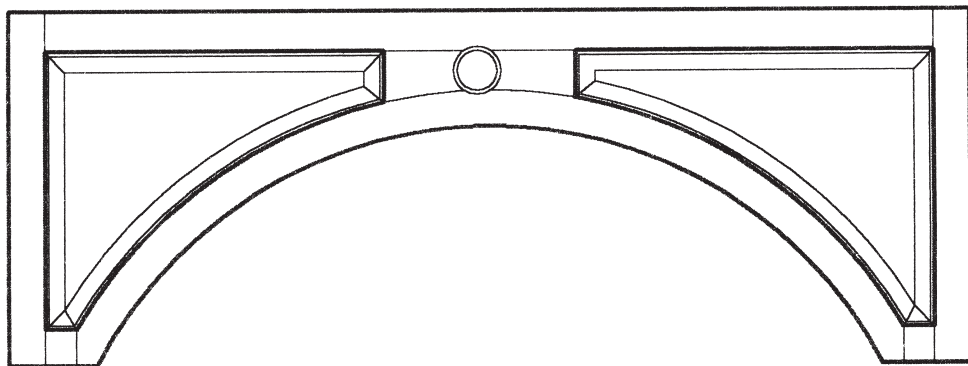
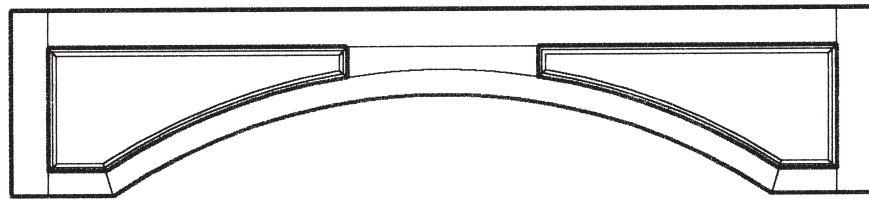
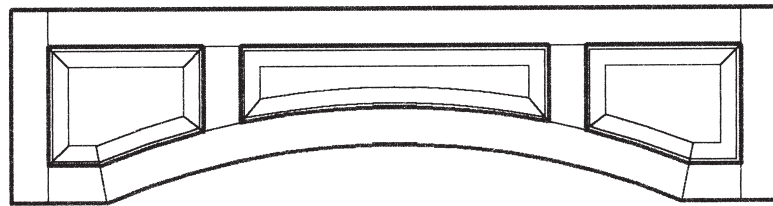

3/4" FRAMING BEAD PROFILES

★ Please note illustrations are for visual concept only, not to scale.

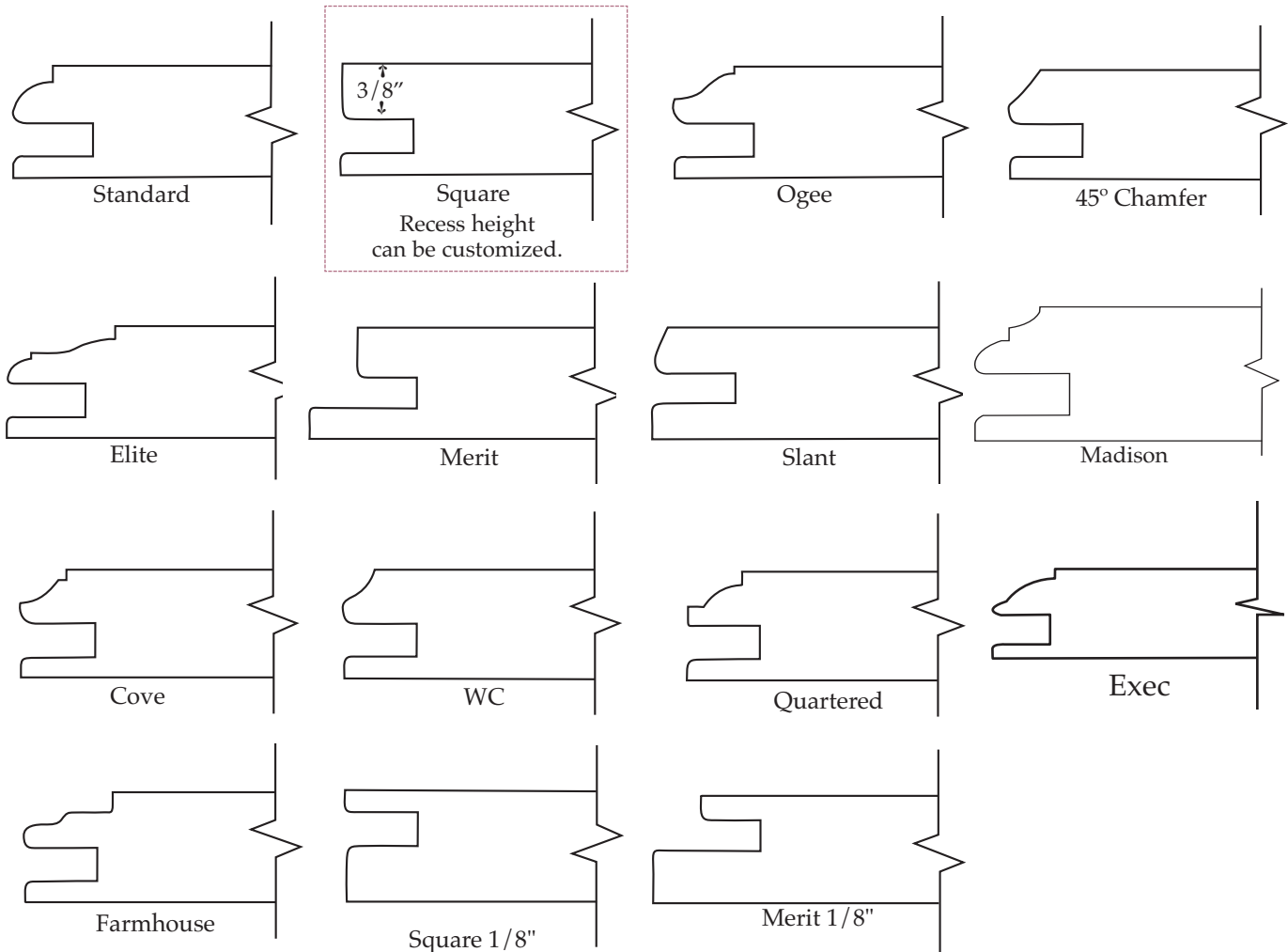

★ Bemenn Custom Wood Products can run 3/4" framing beads on 1" material with the extra thickness on the back of the frame.

RS-BEAD FRAMING SERIES (RS = Rabbit Shelf)

★ Please note illustrations are for visual concept only, not to scale.

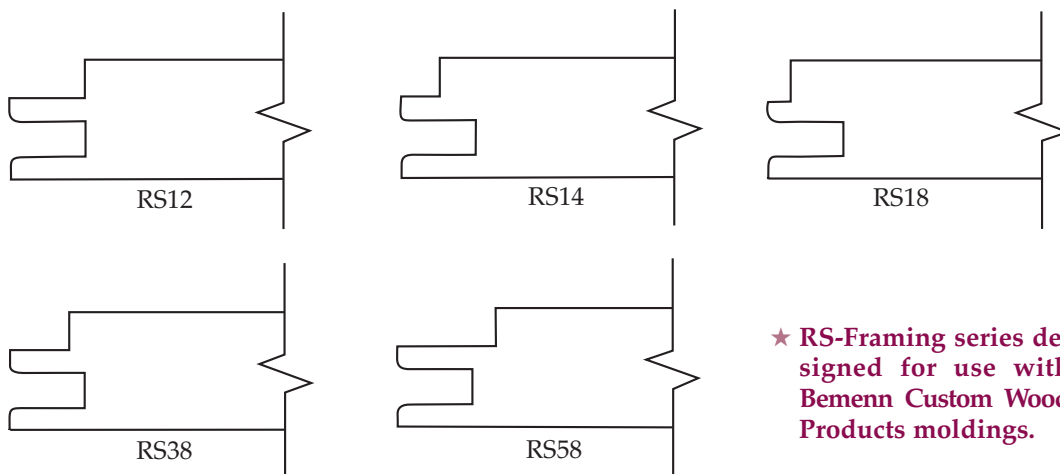

★ RS-Framing series designed for use with Bemenn Custom Wood Products moldings.

Design Options

3/4" DOOR PANEL PROFILES

★ Please note illustrations are for visual concept only, not to scale.

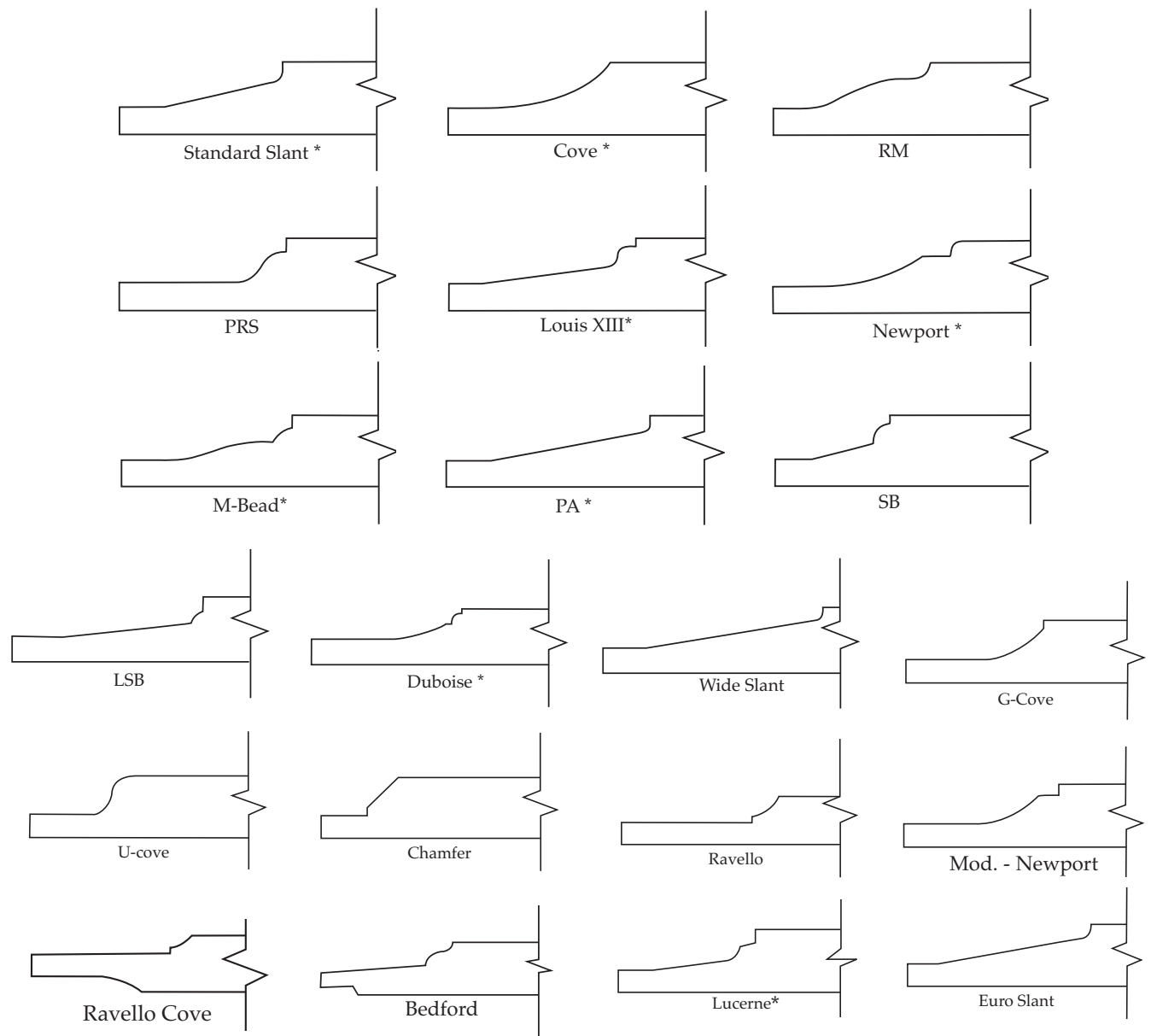

★ Above panels finish thickness is 5/8".

* Indicate panel raise profiles that can be done with 5/8" raw MDF.

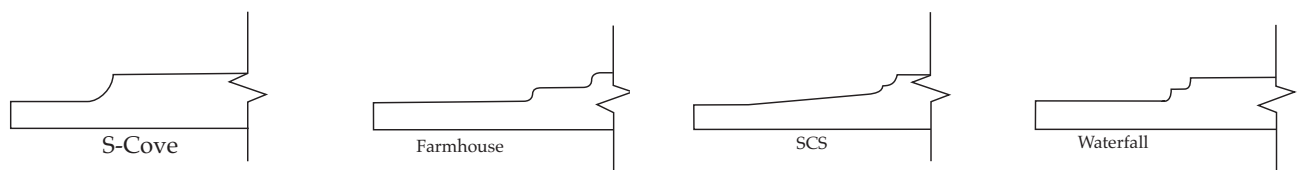

★ Above panels finish thickness is 1/2".

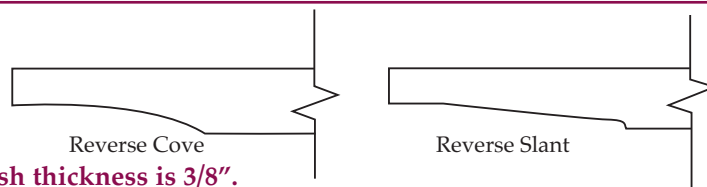

★ Above panels finish thickness is 3/8".

3/4" EDGE PROFILES

★ Please note illustrations are for visual concept only, not to scale.

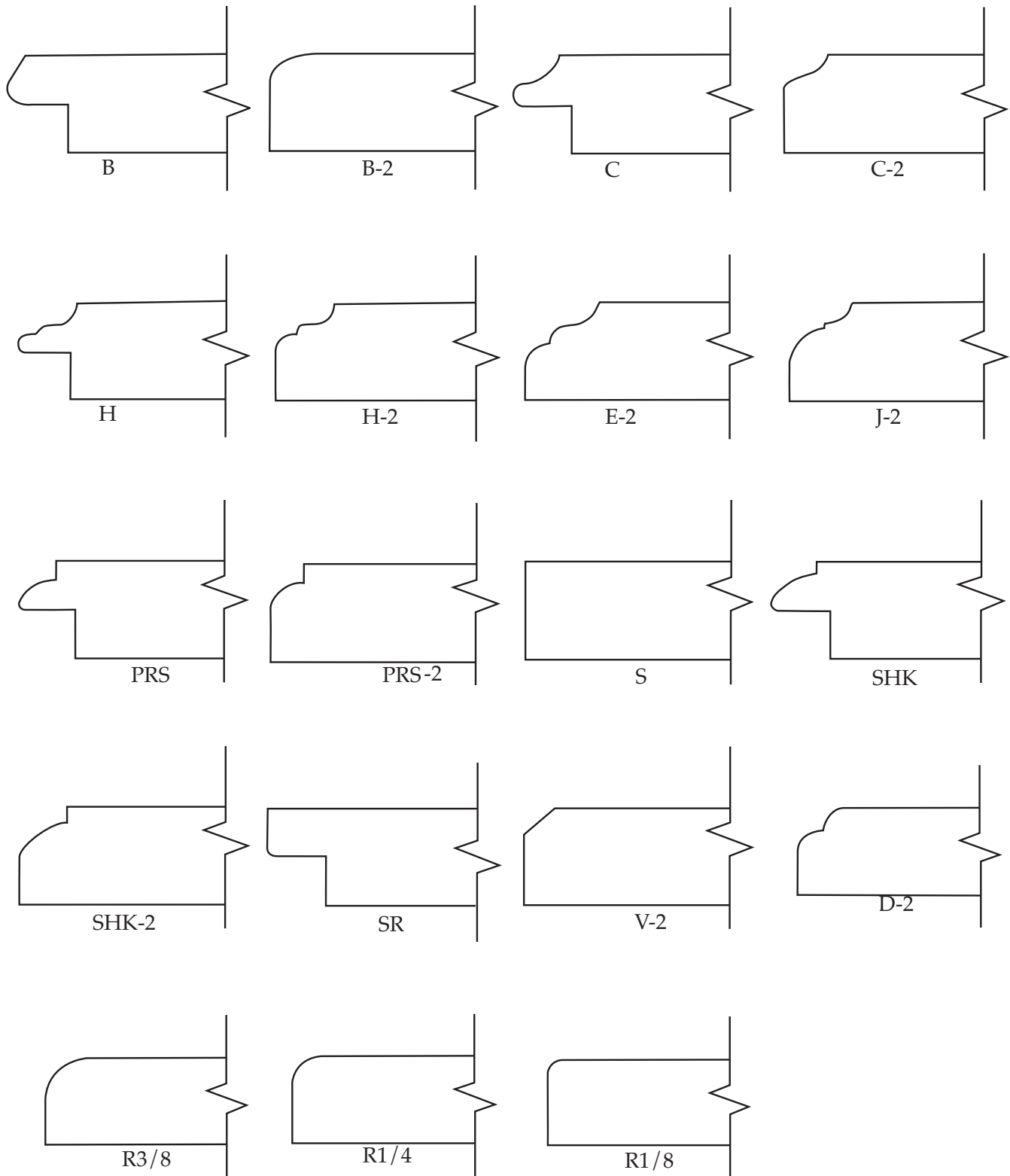

Design Options

3/4" EDGE PROFILES

★ Please note illustrations are for visual concept only, not to scale.

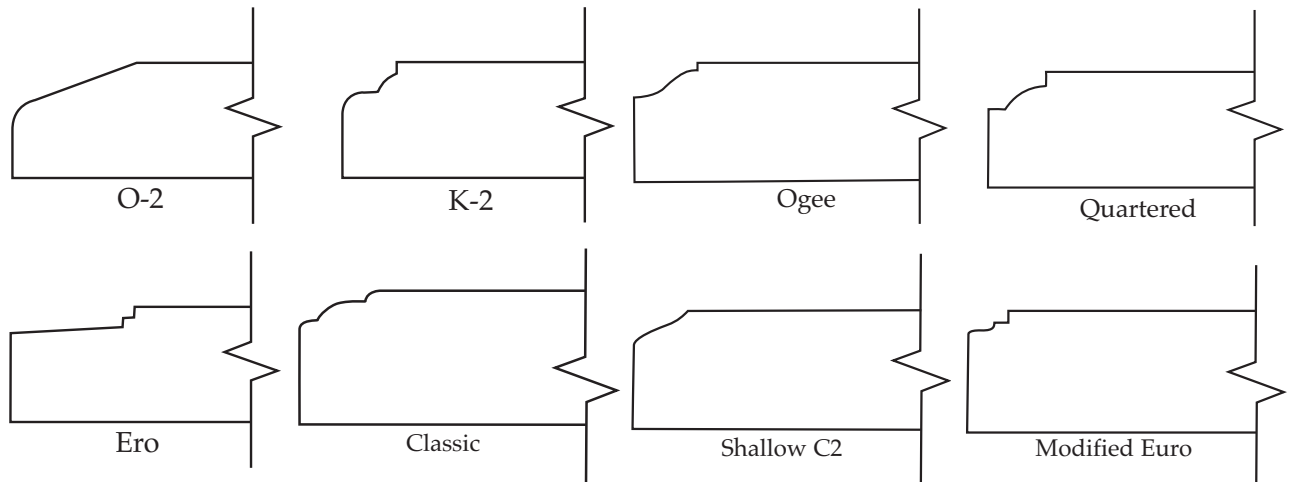

1" FRAMING BEAD PROFILES

★ Please note illustrations are for visual concept only, not to scale.

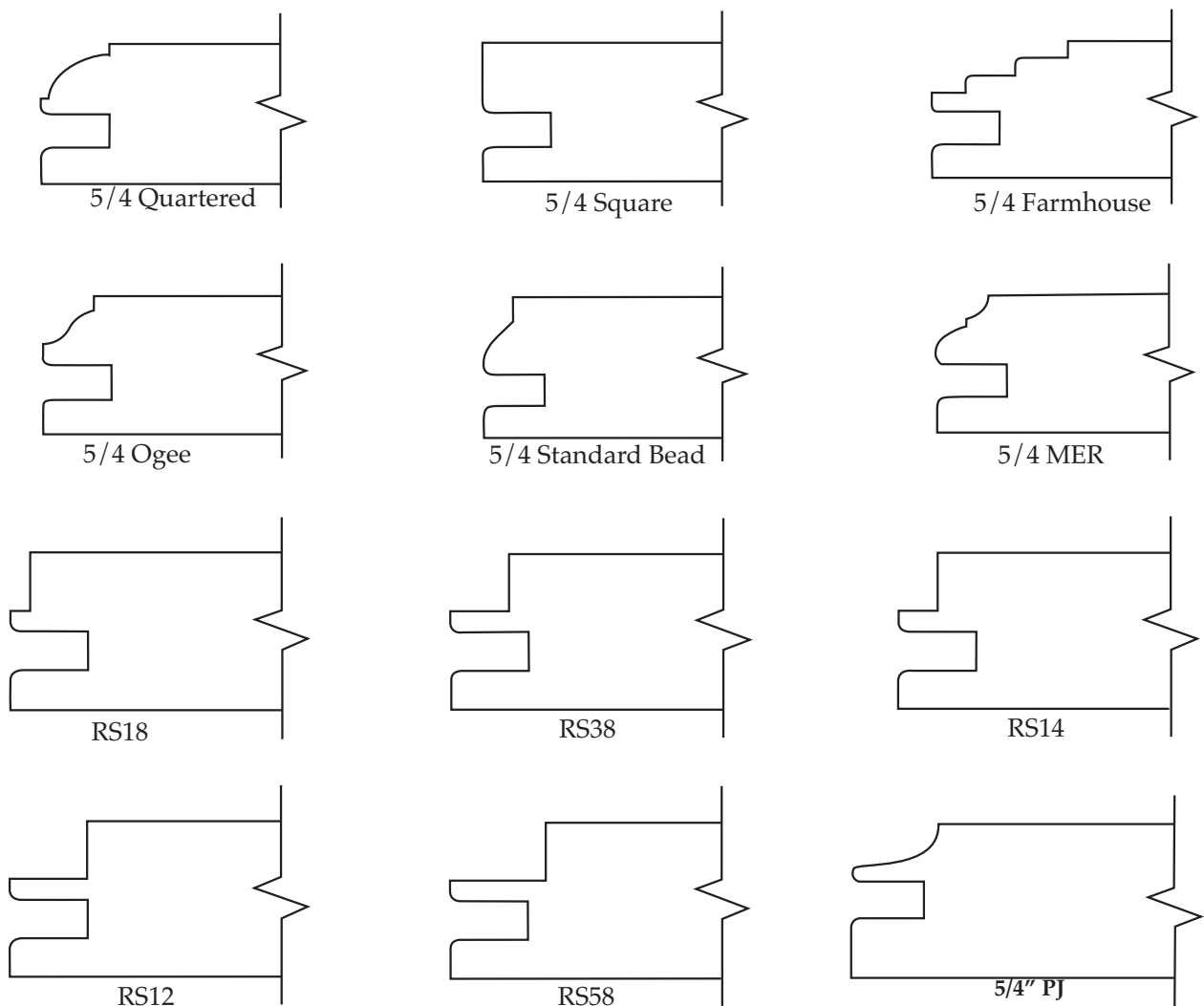

1" PANEL RAISE PROFILES

★ Please note illustrations are for visual concept only, not to scale.

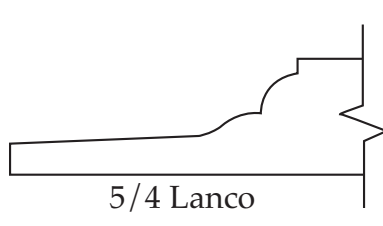
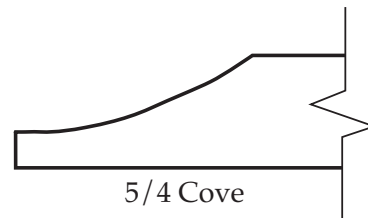
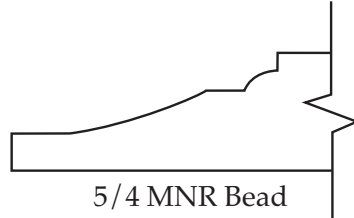
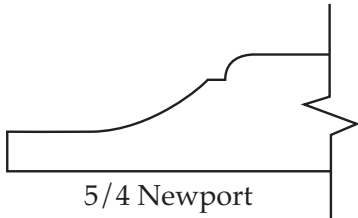
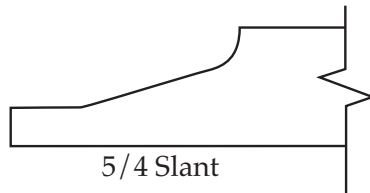
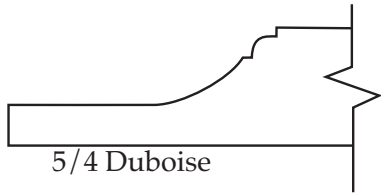

Design Options

1" EDGE PROFILES

★ Please note illustrations are for visual concept only, not to scale.

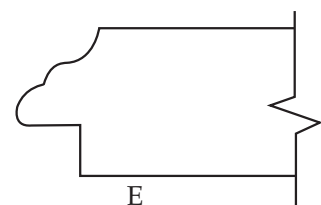
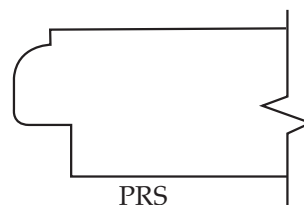
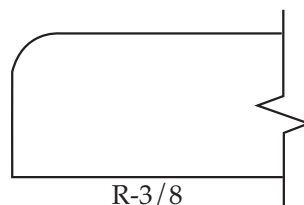
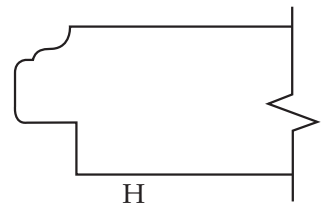
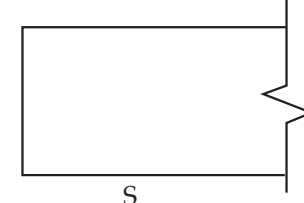
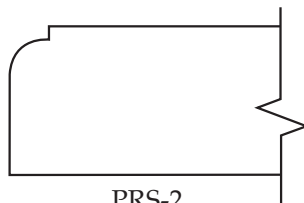
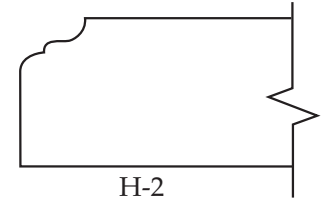
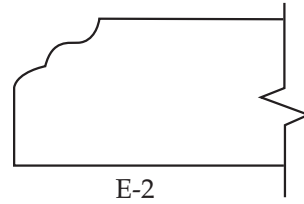
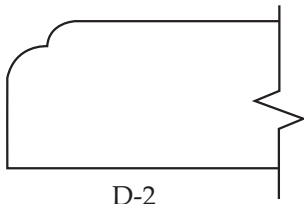
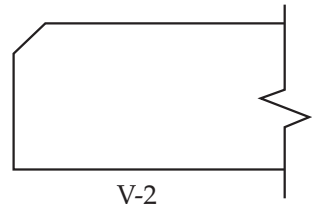
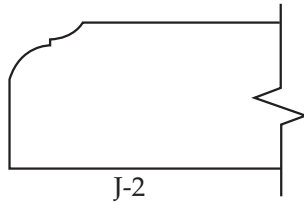
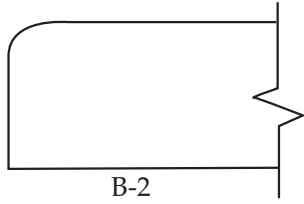

WAINSCOTING

★ Please note illustrations are for visual concept only, not to scale.

- Wainscoting is available in many configurations.

 - Multiple panels wide.

 - Multiple panels high.

- Calculate design cost per panel

Plus

- Material: width x height ÷ 144 inches.

Plus

- Wainscoting charge of \$30.00.

